

# EYEPIECE RETICLES



# Eyepiece Reticles (Graticules)

## Definition:

An eyepiece reticle is a glass disc with a pattern on it that fits at the optical plane inside a microscope eyepiece. It is used to provide alignment, measurement, size or shape comparison, or area counting of specimens by having the reticle pattern superimposed over the specimen image.

The terms reticle, graticule and reticule are all used to describe these items.

## Standard Patterns:

The following pages show the wide range of patterns that we have available. These include:

- Lines and cross-lines for alignment
- Scales and gauges for measurement
- Grids for counting and referencing
- Particle sizing to determine shape, size and quantity of materials or vapours
- Protractors for measuring angles
- Stereology for extracting quantitative information from 3D images
- Many specialist patterns designed by Scientists for specific applications

All Pyser eyepiece reticles are produced on 1.5mm thick optical glass. The image, which is created using a vacuum evaporated chrome process, is correct reading through the glass.

All Pyser eyepiece reticles are available in a variety of standard diameters to suit most microscopes in the marketplace. Other sizes are available to special order.

## Custom Patterns:

If you need something different from the patterns in this catalogue there is no problem, we have a very cost-effective custom reticle facility that is able to make the exact pattern you require.

## History of The Graticules Division of Pyser-SGI Limited

Julius Rheinberg, a member of the Royal Society developed many techniques and processes associated with microphotography. He built the world's first colour camera, invented a grainless photographic emulsion and was well known in optical circles conducting much correspondence with eminent microscopists in Europe. Julius started making graticules for the British Government in 1914, using the skills he developed in photographic processing.

Leslie Rheinberg, the nephew of Julius Rheinberg, formed Graticules Limited in 1946. From 1946 to 1969 the Company operated from laboratories in London using established processes including pigmented fish glues, lead sulphide glass etching, grainless photography, and the introduction of vacuum coating and electroforming in later years.

In 1969 Graticules Limited moved to Tonbridge, taking on additional space in 1976. Expertise, knowledge and developments built up over nearly 100 years enables the Company to offer a comprehensive range of products for microscopy, optics, education, medicine/research, defence and industry.

Graticules Limited was purchased in 1997 by Pyser-SGI Limited, a company producing specialised precision optical products since 1932, creating a powerful knowledgeable company manufacturing optics, optical instruments and electro-optical systems.

## Selecting Your Reticle:

There are two things that need to be defined when selecting your reticle:

1. The pattern that is suitable for your application
2. The diameter required to fit your eyepiece

The application or method that you are working to will normally determine the reticle pattern that will be required. For instance, if you are doing straightforward length measurements you may require a simple horizontal scale, if you are performing asbestos analysis you are most likely to need a Walton & Beckett reticle.

One very common mistake that is made when selecting the reticle is with the size of the pattern. If you have a 10mm length scale (such as our NE1) in the eyepiece this does not mean that it will measure 10mm at the specimen stage. You have to take into account the objective magnification. Thus if you are using a 10x objective lens then the 10mm scale will represent 1mm at the specimen stage ( $10\text{mm}/10\text{x} = 1\text{mm}$ ). In practical use, if you have a specimen of typically 50 micron (0.050mm) length and you are using a 40x objective then you will need to select a reticle pattern that has a scale range capable of measuring a size of 2mm ( $0.050\text{mm} \times 40\text{x} = 2\text{mm}$ ).

The reticle is fitted inside the eyepiece at the optical plane. The optical plane being the position where both the formed images of the specimen and the reticle are in focus. The reticle diameter needs to be a fraction smaller than the inside diameter of the eyepiece at the point of the optical plane. Most modern eyepieces have a reticle holder or threaded bush to secure the reticle in the correct position. If there is no fixing device in the eyepiece then Pyser offer a measuring and fitting service.

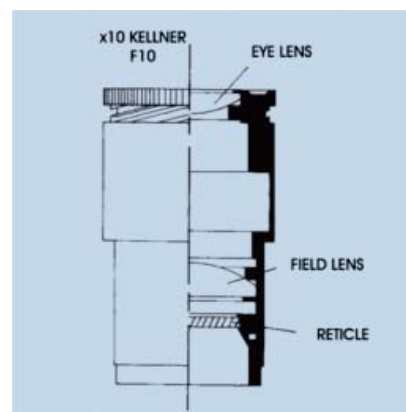

*Typical position of reticle in Kellner type eyepiece*

## Measuring and Fitting Service:

When fitting reticles it is essential this is done in clean areas, any speck of dust on the reticle will be visible when installed in the microscope. The locating and securing of the reticle can also cause problems. Due to these difficulties and the uncertainty that many people have about sizing a reticle, Pyser-SGI offer a measuring and fitting service.

Customers send us their eyepiece and we carry out the following actions:

1. Check to see if fitting a reticle is feasible and then measure the internal dimensions to determine the diameter required.
2. Provide a quotation for the supply and fitting of the reticle.
3. Once order/payment has been received Pyser will make and fit the reticle then despatch it back to you.

# LINES AND CROSSES

## Single Lines

### NE50

For measurement of large objects in conjunction with graduated mechanical stage, and for alignment. Image covers entire field of view

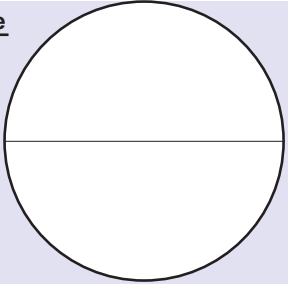
Pattern	Description	Diameter	Order Code	
NE50	Single line, nominal width 0.02mm.	16mm	01B16238	
		19mm	01B19238	
		21mm	01B21238	
		23mm	01B23238	
		24mm	01B24238	
		26mm	01B26238	
		27mm	01B27238	
		Special	01BSP238	

## Crosslines

### NE8, NE81, NE82

Used as for NE50 but for measurements in two directions and for sighting and alignment. Image covers entire field of view

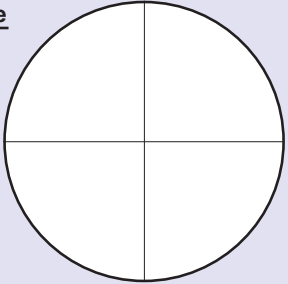
Pattern	Description	Diameter	Order Code	
NE8	Crosslines, nominal line width 0.02mm.	16mm	01B16206	
		19mm	01B19206	
		20mm	01B20206	
		21mm	01B21206	
		23mm	01B23206	
		24mm	01B24206	
		26mm	01B26206	
		27mm	01B19206	
Special	01BSP206			

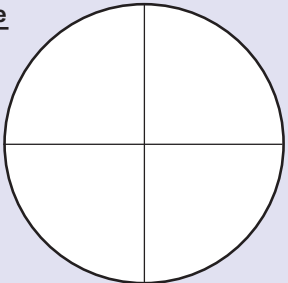
Pattern	Description	Diameter	Order Code	
NE81	Crosslines, nominal line width 0.04mm	16mm	01B16234	
		19mm	01B19234	
		21mm	01B21234	
		23mm	01B23234	
		24mm	01B24234	
		26mm	01B26234	
		27mm	01B27234	
		Special	01BSP234	

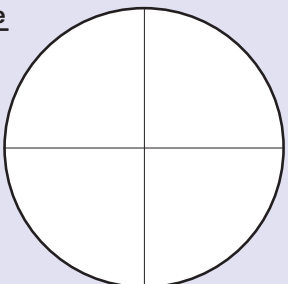
Pattern	Description	Diameter	Order Code	
NE82	Crosslines, nominal line width 0.005mm	16 mm	01B16235	
		19mm	01B19235	
		21mm	01B21235	
		23mm	01B23235	
		24mm	01B24235	
		26mm	01B26235	
		27mm	01B27235	
		Special	01BSP235	

## Broken Crosslines

### NE56

Use as crossed lines. Broken lines enable fine detail to be seen at the breaks. A thin boundary would be lost behind a continuous line. Image covers entire field of view.

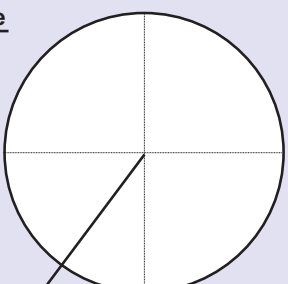
Pattern	Description	Diameter	Order Code	
NE56	Broken crossline.	16mm	01B16231	
		19mm	01B19231	
		21mm	01B21231	
		23mm	01B23231	
		24mm	01B24231	
		26mm	01B26231	
		27mm	01B27231	
		Special	01BSP231	

# Crossed Gauge Lines

## NE53, NE54

Use as crossed lines, but for measuring distances between lines. Greater accuracy can be obtained by locating the specimen detail between the reticle gauge pair. Image covers entire field of view.

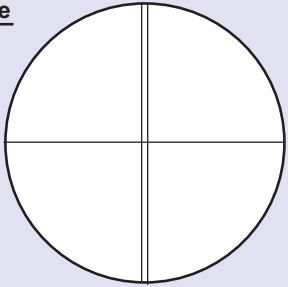
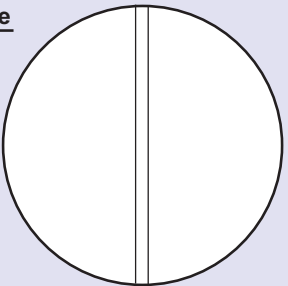
Pattern	Description	Diameter	Order Code	
NE53	Two vertical lines 0.1mm apart with horizontal line.	16mm	01B16230	
		19mm	01B19230	
		21mm	01B21230	
		23mm	01B23230	
		24mm	01B24230	
		26mm	01B26230	
		27mm	01B27230	
		Special	01BSP230	
NE54	Two vertical lines 0.2mm apart.	16mm	01B16239	
		19mm	01B19239	
		21mm	01B21239	
		23mm	01B23239	
		24mm	01B24239	
		26mm	01B26239	
		27mm	01B27239	
		Special	01BSP239	

# EYEPIECE SCALES

## Horizontal & Vertical Scales

### NE1, NE2, NE5, NE20 NE28, NE31, NE41, NE120

Used for measuring lengths of specimen or distances between points on a variety of different shaped objects.

NE1 Scale: This eyepiece reticle has an overall length of 10.00mm with 100 subdivisions of 0.1mm. When used with a x10 objective each division will represent 10 microns on the specimen. By dividing the division of the chosen reticle by the magnification of the objective one obtains an approximate value that each division will represent on the stage.

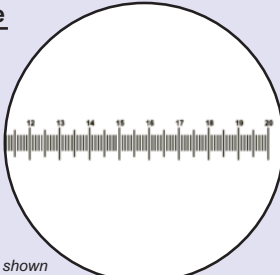
Pattern	Description	Diameter	Order Code	
NE120	Horizontal micrometer 20mm long with 200 divisions of 0.1mm.	23mm	01B23320	
		24mm	01B24320	
		26mm	01B26320	
		27mm	01B27320	
		Special	01BSP320	

*Part scale shown*

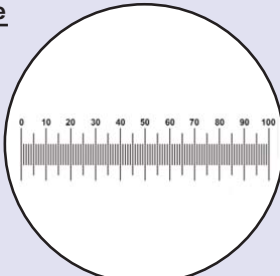
Pattern	Description	Diameter	Order Code	
NE1	Horizontal micrometer 10mm long with 100 divisions of 0.1mm.	16mm	01B16201	
		19mm	01B19201	
		20mm	01B20201	
		21mm	01B21201	
		23mm	01B23201	
		24mm	01B24201	
		26mm	01B26201	
		27mm	01B27201	
Special	01BSP201			

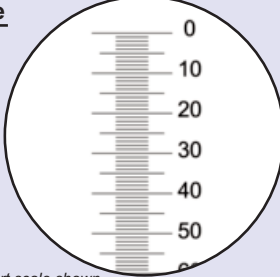
Pattern	Description	Diameter	Order Code	
NE2	Vertical micrometer 10mm long with 100 divisions of 0.1mm.	16mm	01B16202	
		19mm	01B19202	
		20mm	01B20202	
		21mm	01B21202	
		23mm	01B23202	
		24mm	01B24202	
		26mm	01B26202	
		27mm	01B27202	
Special	01BSP202			

*Part scale shown*

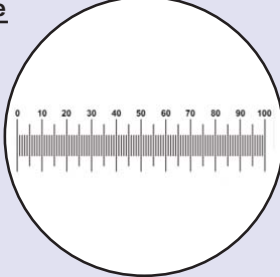
Pattern	Description	Diameter	Order Code	
NE5	Horizontal micrometer 5mm long with 100 divisions of 0.05mm.	16mm	01B16203	
		19mm	01B19203	
		21mm	01B21203	
		23mm	01B23203	
		24mm	01B24203	
		26mm	01B26203	
		27mm	01B27203	
		Special	01BSP203	

# EYEPIECE SCALES

## Horizontal & Vertical Scales

Used for measuring lengths of specimen or distances between points on a variety of different shaped objects.

Pattern	Description	Diameter	Order Code
NE28	Horizontal scale 1mm long, with 100 divisions of 0.01mm.	16mm	01B16217
		19mm	01B19217
		21mm	01B21217
		23mm	01B23217
		24mm	01B24217
		26mm	01B26217
		27mm	01B27217
		Special	01BSP217

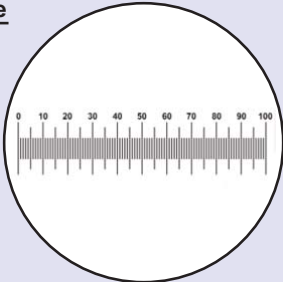

Pattern	Description	Diameter	Order Code
NE41	Horizontal scale 10mm long with 200 divisions of 0.05mm.	16mm	01B16223
		19mm	01B19223
		21mm	01B21223
		23mm	01B23223
		24mm	01B24223
		26mm	01B26223
		27mm	01B27223
		Special	01BSP223

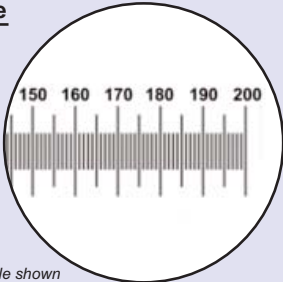

*Part scale shown*

Pattern	Description	Diameter	Order Code
NE20	Horizontal scale 0.1" long with 100 divisions of 0.001".	16mm	01B16214
		19mm	01B19214
		21mm	01B21214
		23mm	01B23214
		24mm	01B24214
		26mm	01B26214
		27mm	01B27214
		Special	01BSP214

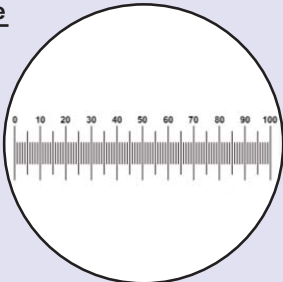

Pattern	Description	Diameter	Order Code
NE31	Horizontal scale 0.5" long with 100 divisions of 0.005".	16mm	01B16219
		19mm	01B19219
		21mm	01B21219
		23mm	01B23219
		24mm	01B24219
		26mm	01B26219
		27mm	01B27219
		Special	01BSP219

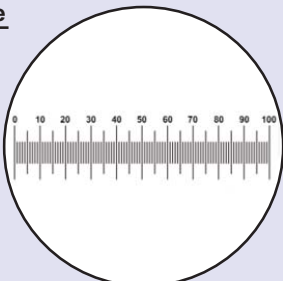



# EYEPIECE SCALES

## Crossed Scales

### NE17, NE18

Used as horizontal and vertical scales, and especially useful when interested in measurements in different axis

Pattern	Description	Diameter	Order Code
NE17	Crossed micrometer scales. Each 10mm long with 100 divisions of 0.1mm.	16mm	01B16212
		19mm	01B19212
		20mm	01B20212
		21mm	01B21212
		23mm	01B23212
		24mm	01B24212
		26mm	01B26212
		27mm	01B27212
Special	01BSP212		

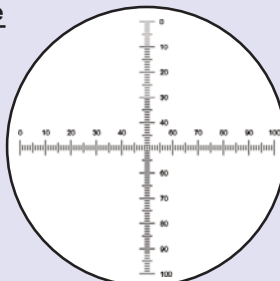

Pattern	Description	Diameter	Order Code
NE18	Crossed micrometer scales. Each 5mm long with 100 divisions of 0.05mm.	16mm	01B16213
		19mm	01B19213
		21mm	01B21213
		23mm	01B23213
		24mm	01B24213
		26mm	01B26213
		27mm	01B27213
		Special	01BSP213

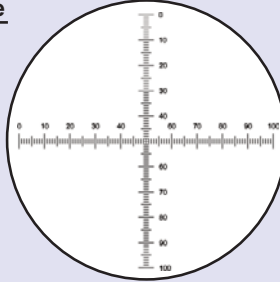

### NE72 NEW

Pattern	Description	Diameter	Order Code
NE72	Crossed micrometer scales. Each 20mm long with 200 divisions of 0.1mm.	23mm	01B23303
		24mm	01B24303
		26mm	01B26303
		27mm	01B27303
		Special	01BSP303

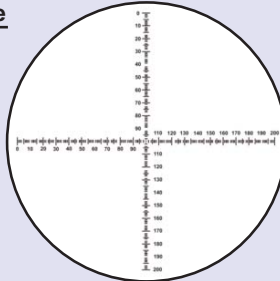

### NE70 NEW

Pattern	Description	Diameter	Order Code
NE70	Crossed micrometer scales. (imperial). Each 0.8" long with 400 divisions of 0.002".	21mm	01B21301
		23mm	01B23301
		24mm	01B24301
		26mm	01B26301
		27mm	01B27301
Special	01BSP301		

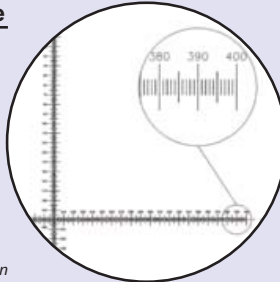

*Part scale shown*

## Scales with Crosslines

### NE7, NE7N

The inclusion of a crossline assists in ensuring alignment of the reticle with edges, etc, in the specimen.

Pattern	Description	Diameter	Order Code
NE7	Horizontal micrometer scale 10mm long, with 100 divisions of 0.1mm and crosslines	16mm	01B16204
		19mm	01B19204
		21mm	01B21204
		23mm	01B23204
		24mm	01B24204
		26mm	01B26204
		27mm	01B27204
		Special	01BSP204

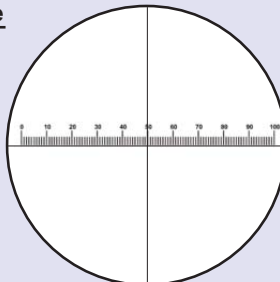

Pattern	Description	Diameter	Order Code
NE7N	Horizontal micrometer scale 10mm long with 100 divisions of 0.1mm, includes crosslines and additional 10mm square.	16 mm	01B16205
		19mm	01B19205
		21mm	01B21205
		23mm	01B23205
		24mm	01B24205
		26mm	01B26205
		27mm	01B27205
		Special	01BSP205

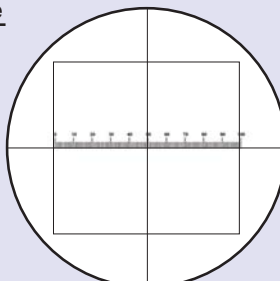

## Scales with Crosslines

### NE77, NE777

The inclusion of a crossline assists in ensuring alignment of the reticle with edges, etc, in the specimen.

Pattern	Description	Diameter	Order Code
NE77	Horizontal micrometer scale 5mm long with 100 divisions of 0.05mm and crosslines.	16mm	01B16233
		19mm	01B19233
		21mm	01B21233
		23mm	01B23233
		24mm	01B24233
		26mm	01B26233
		27mm	01B27233
		Special	01BSP233

Pattern	Description	Diameter	Order Code
NE777	Horizontal micrometer scale 0.5" long with divisions of 0.005" and crosslines.	16mm	01B16237
		19mm	01B19237
		21mm	01B21237
		23mm	01B23237
		24mm	01B24237
		26mm	01B26237
		27mm	01B27237
		Special	01BSP237

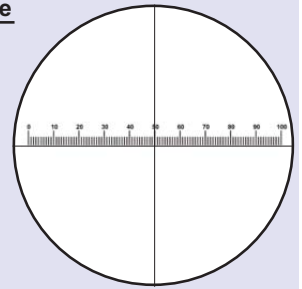
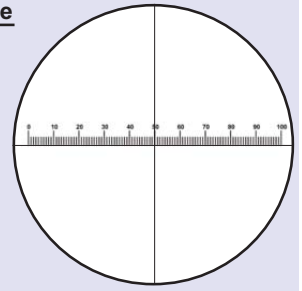

## SQUARES AND GRIDS

Note: These may need to be calibrated, according to intended use. There are a number of uses for the grids and squares listed and they will largely depend on the individual user's application.

### Sectoring

A squared reticle might be used for the systematic examination of a specimen. Some of the squared patterns are numbered to aid the identification of areas of interest. Sectoring is particularly useful for making drawings of specimens onto graph paper. The chessboard type of pattern helps the user to distinguish the position being examined: the darker squares are translucent, while the lighter ones are transparent, avoiding eyestrain in prolonged counting as may be necessary in haematology. These patterns provide the same advantages when used with image analysis and capture devices.

### Counting

A squared reticle can be used for counting. Here the basic principle is that a small area of the specimen is analysed in order to obtain information about the total area. This minimises sometimes wasteful work enabling simple analysis of a particular area. An example of this would be the comparison of large to small particles in a specimen. By using the Miller reticle (NE57) only the smaller particles in the small square are counted, the result being multiplied by ten for comparison with the number of larger particles in the large square.

### Squared Grids

Squared grids can be used in particle size analysis as simple technical aids where sophisticated image analysis systems are not required. The areas of the particles to be measured can be estimated by simply counting the number of squares occupied by those particles. It is necessary to estimate fractions of a square or make a rule (e.g. count as a square all partly covered squares at the right and bottom sides of the grid, and ignore partly covered squares at the left and upper sides of the square). This method would only be useful for a fairly crude estimation of a large diameter. For more detailed optical analysis it is advisable to use a specialised reticle such as those in the Particle Size Analysis section on page 11



## Squared Grids

### NE10, NE11, NE34

Simple grids are convenient for making sketches of the observed specimen. They are also useful for particle counting. NE10 and NE11 grids cover the full area. NE34 grid is 10mm x 10mm.

Pattern	Description	Diameter	Order Code	
NE10	Grid (net) 0.5mm pitch.	16mm	01B16207	
		19mm	01B19207	
		21mm	01B21207	
		23mm	01B23207	
		24mm	01B24207	
		26mm	01B26207	
		27mm	01B27207	
		Special	01BSP207	
NE11	Grid (net) 1.0mm pitch.	16mm	01B16209	
		19mm	01B19209	
		21mm	01B21209	
		23mm	01B23209	
		24mm	01B24209	
		26mm	01B26209	
		27mm	01B27209	
		Special	01BSP209	
NE34	10mm x 10mm grid of 0.1mm squares	16mm	01B16300	
		19mm	01B19300	
		21mm	01B21300	
		23mm	01B23300	
		24mm	01B24300	
		26mm	01B26300	
		27mm	01B27300	
		Special	01BSP300	

## Indexed Grids

### NE10A, NE11A, NE34A

Useful for particle counting, particularly where reference is needed between workers. Also useful for area of specimen determinations.

Pattern	Description	Diameter	Order Code	
NE10A	Numbered grid 5mm x 5mm. 0.5mm pitch. Marked 1-10 and A-J.	16mm	01B16208	
		19mm	01B19208	
		21mm	01B21208	
		23mm	01B23208	
		24mm	01B24208	
		26mm	01B26208	
		27mm	01B27208	
		Special	01BSP208	
NE11A	Numbered grid 10mm x 10mm. 1.0mm pitch. Marked 1-10 and A-J.	16mm	01B16210	
		19mm	01B19210	
		21mm	01B21210	
		23mm	01B23210	
		24mm	01B24210	
		26mm	01B26210	
		27mm	01B27210	
		Special	01BSP210	
NE34A	Numbered grid 1mm x 1mm. 0.1mm pitch. Marked 1-10 and A-J.	16mm	01B16220	
		19mm	01B19220	
		21mm	01B21220	
		23mm	01B23220	
		24mm	01B24220	
		26mm	01B26220	
		27mm	01B27220	
		Special	01BSP220	

## Indexed Grids

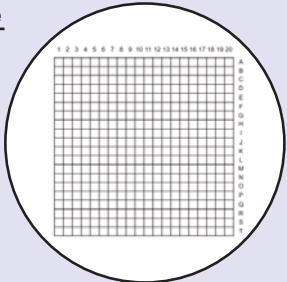
Pattern	Description	Diameter	Order Code	
NE71	Index pattern	21 mm	01B21302	
<b>NEW</b>	20 x 20 grid of 0.5mm squares	23mm	01B23302	
		24mm	01B24302	
		26mm	01B26302	
		27mm	01B27302	
		Special	01BSP302	

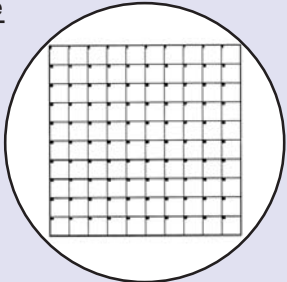
Pattern	Description	Diameter	Order Code	
NE35	Numbered grid 10mm x 10mm. 1mm indexed squares.	16mm	01B16221	
		19mm	01B19221	
		21mm	01B21221	
		23mm	01B23221	
		24mm	01B24221	
		26mm	01B26221	
		27mm	01B27221	
		Special	01BSP221	

## Chessboard Squares

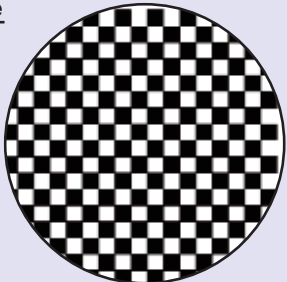
Pattern	Description	Diameter	Order Code	
NE15	Chessboard (net) 2.0mm squares.	16mm	01B16211	
		19mm	01B19211	
		21mm	01B21211	
		23mm	01B23211	
		24mm	01B24211	
		26mm	01B26211	
		27mm	01B27211	
		Special	01BSP211	

## Squares and Grids

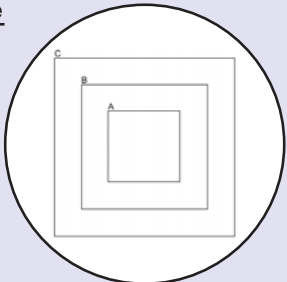
Pattern	Description	Diameter	Order Code	
NE38	Squares 10mm, 7mm & 4mm.	16mm	01B16222	
		19mm	01B19222	
		21mm	01B21222	
		23mm	01B23222	
		24mm	01B24222	
		26mm	01B26222	
		27mm	01B27222	
		Special	01BSP222	

## Miller Squares

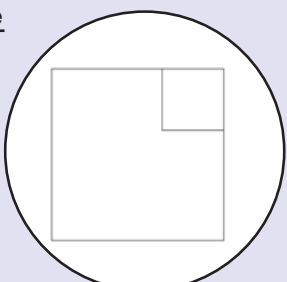
Pattern	Description	Diameter	Order Code	
NE57	Miller 7 x 7 mm grid.	16mm	01B16232	
		19mm	01B19232	
		21mm	01B21232	
		23mm	01B23232	
		24mm	01B24232	
		26mm	01B26232	
		27mm	01B27232	
		Special	01BSP232	

The ratio of large to small square is 9:1. Originally designed for haematology, they can be utilised for rapid counting of any evenly spread field of particles.

References: American Journal of Clinical Pathology Vol. 20, 1950, page 1079. "Time Saving Device For Counting Reticulocyte." G.Brescher and Schneiderman.

Practical Haematology-J.D.Dacy. Published by J.A.Churchill. 2nd Edition 1956

# Whipple Grid

## NE29

Originally designed for water particle analysis, but may be used for other aspects of particle counting. Grid shown: Ratio of full square to smallest is 50:1. Area is 2500:1 Reference: Microscopy of Drinking Water.

*Please note the NE29 is also available with a 10mm x 10mm grid to special order.*

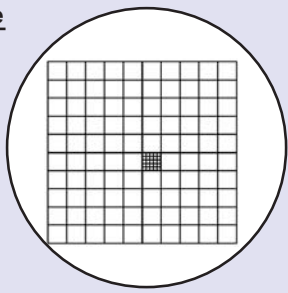
Pattern	Description	Diameter	Order Code	
NE29	Whipple grid 100 squares in 7mm. area.	16mm	01B16218	
		19mm	01B19218	
		21mm	01B21218	
		23mm	01B23218	
		24mm	01B24218	
		26mm	01B26218	
		27mm	01B27218	
		Special	01BSP218	

# CIRCLE GAUGES AND PROTRACTORS

## Concentric Circles

### NE42, NE43, NE44, NE47

Can be used for two-way measurement when calibrated as a micrometer.

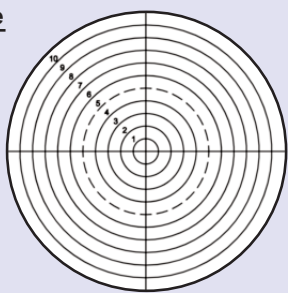
Pattern	Description	Diameter	Order Code	
NE42	Concentric circles 0.25mm – 2.5mm diameter. 10 circles.	16mm	01B16224	
		19mm	01B19224	
		21mm	01B21224	
		23mm	01B23224	
		24mm	01B24224	
		26mm	01B26224	
		27mm	01B27224	
		Special	01BSP224	

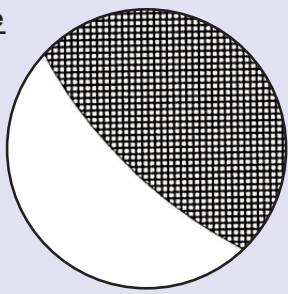
Pattern	Description	Diameter	Order Code	
NE43	Concentric circles 0.5mm – 5mm diameter. 10 circles.	16mm	01B16225	
		19mm	01B19225	
		21mm	01B21225	
		23mm	01B23225	
		24mm	01B24225	
		26mm	01B26225	
		27mm	01B27225	
		Special	01BSP225	

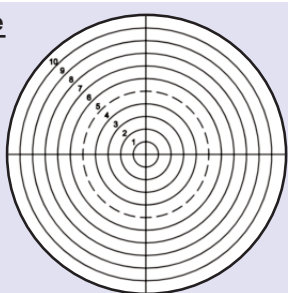
Pattern	Description	Diameter	Order Code	
NE44	Concentric circles 1mm – 10mm diameter. 10 circles.	16mm	01B16226	
		19mm	01B19226	
		21mm	01B21226	
		23mm	01B23226	
		24mm	01B24226	
		26mm	01B26226	
		27mm	01B27226	
		Special	01BSP226	

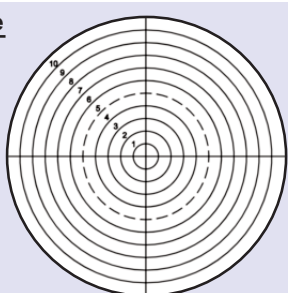
Pattern	Description	Diameter	Order Code	
NE47	Concentric circles 2mm – 20mm diameter. 10 circles.	21mm	01B21228	
		23mm	01B23228	
		24mm	01B24228	
		26mm	01B26228	
		27mm	01B27228	
		Special	01BSP228	

## Concentric Circles + Cross Scales

### NE48

Similar to concentric circles, but with graduated cross hairs.

Pattern	Description	Diameter	Order Code
NE48	Concentric circles, 10 circles 1mm-10mm, with graduated cross hairs	16mm	01B16242
		19mm	01B19242
		21mm	01B21242
		23mm	01B23242
		24mm	01B24242
		26mm	01B26242
		27mm	01B27242
		Special	01BSP242

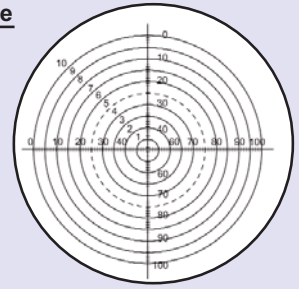

## Concentric Circles

### NE22

This design leaves the circles clear of obstruction. In addition the intermediate lines are broken to improve ease of reading.

Pattern	Description	Diameter	Order Code
NE22	Concentric circles 0.5mm - 12mm diameter, 24 circles.	16mm	01B16215
		19mm	01B19215
		21mm	01B21215
		23mm	01B23215
		24mm	01B24215
		26mm	01B26215
		27mm	01B27215
		Special	01BSP215

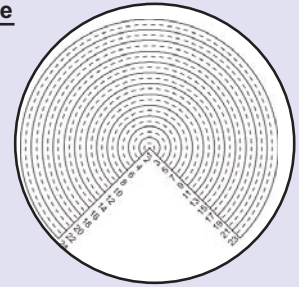

## Gauge Pairs

### NE19

Gauge pairs occupying a field of view of 10mm. Each gauge is proportional to its adjacent number. Approximate size of smallest pair = 0.1mm.

Pattern	Description	Diameter	Order Code
NE19	Gauge pairs	16mm	01B16241
		19mm	01B19241
		21mm	01B21241
		23mm	01B23241
		24mm	01B24241
		26mm	01B26241
		27mm	01B27241
		Special	01BSP241

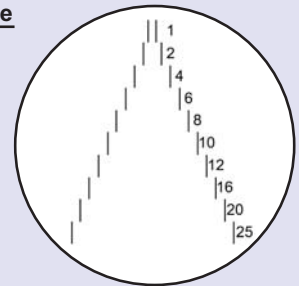

## PROTRACTORS

Placed in the eyepiece, these are used in the same manner as ordinary protractors.

### Half Protractor

#### NE25

Pattern	Description	Diameter	Order Code
NE25	Half protractor scale 10mm diameter divided in degrees.	16mm	01B16216
		19mm	01B19216
		21mm	01B21216
		23mm	01B23216
		24mm	01B24216
		26mm	01B26216
		27mm	01B27216
		Special	01BSP216

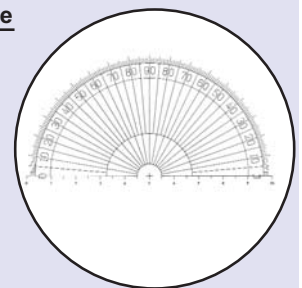

### Full Protractor

#### NE45

Pattern	Description	Diameter	Order Code
NE45	Full protractor scale 10mm diameter divided in degrees.	16mm	01B16227
		19mm	01B19227
		21mm	01B21227
		23mm	01B23227
		24mm	01B24227
		26mm	01B26227
		27mm	01B27227
		Special	01BSP227

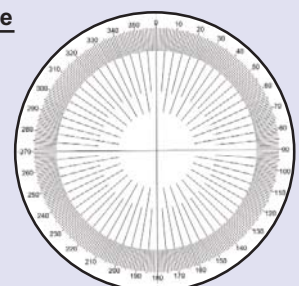

# PARTICLE SIZING AND DISTRIBUTION

The use of the eyepiece reticles shown in this section make it possible to analyse specimens containing particles as an alternative, or in addition to, sieving. Reticles for particle size analysis are particularly popular when there are only limited quantities of particles or where particles are smaller than 50 micron diameter. Typical substances analysed are sand grains, soil particles, plant seeds, fertilizers, abrasives, liquid droplets, pigments, pulverised coal, silica, fibres and fine dust.

The basic principle employed is to compare particles to the globes and circles of varying sizes that appear on the reticle – dark particles being compared to solid globes, and light or transparent ones to the circles. Naturally the procedure varies with the reticle concerned, more information about which is given alongside each reticle description.

Please note that for calibration the circles and globes will represent particles smaller in diameter by the magnification of the objective.

## Patterson Globes and Circles

### NG1

The reticle consists of a central rectangle, sub-divided into nine smaller rectangles with a number of increasing circles outside the top and bottom horizontal edges. The marked figures are the diameters of the circles in units. 250 units represent the horizontal length of the large rectangle. Rectangle size is 4.5mm x 2.025mm. Circle sizes in microns are nominally 450, 360, 270, 225, 180, 145, 110, 74, 37 and 18.

Pattern	Description	Diameter	Order Code
NG1	Patterson globes/circles.	16mm	01B16250
		19mm	01B19250
		21mm	01B21250
		23mm	01B23250
		24mm	01B24250
		26mm	01B26250
		27mm	01B27250
		Special	01BSP250

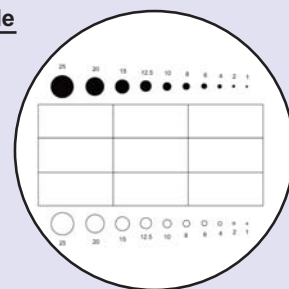

Reference: H.S.Patterson and W.Cawood. Transactions of the Faraday Society, Vol. 32 Feb 1936. "The Determination of Size Distribution in Smokes." Pp. 1084-1088.

## Porton

### NG2

The circle areas of the Porton reticles increase with Root 2 progression as do the divisions on the right hand side of the rectangle. These divisions are numbered for convenience. Rectangle size is 4.5mm x 2.025mm. The specimen is racked on the mechanical stage of the microscope and traverses are taken right across the deposit sizing all the particles encountered.

Pattern	Description	Diameter	Order Code
NG2	Original Porton globes/circle	16mm	01B16251
		19mm	01B19251
		21mm	01B21251
		23mm	01B23251
		24mm	01B24251
		26mm	01B26251
		27mm	01B27251
		Special	01BSP251

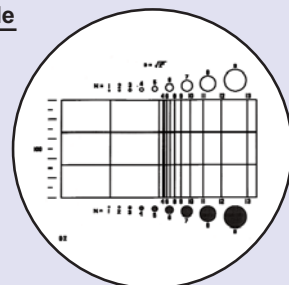

Reference: K.R.May, Journal of Scientific Instruments Vol. 22 Oct 1945. "The Cascade Impactor." An instrument for sampling coarse aerosols.



## New Porton

### NG12

The NG12 is particularly useful since the array of globes and circles are conveniently close to where the particles pass. At the end of each band of the sample the mechanical stage is traversed vertically to take in the next band until the whole sample has been covered.

Reference: K.R.May, Journal of Scientific Instruments Vol. 42 1965. "A New Graticule for Particle Counting and Sizing." Pp 500-501.

Pattern	Description	Diameter	Order Code
NG12	Modified Porton pattern globes/circle.	16mm	01B16253
		19mm	01B19253
		21mm	01B21253
		23mm	01B23253
		24mm	01B24253
		26mm	01B26253
		27mm	01B27253
		Special	01BSP253

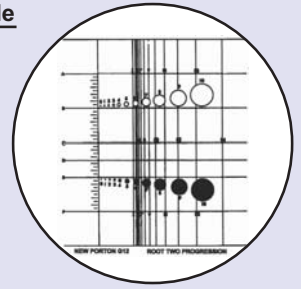

## British Standard Reticle

### NG10

In this reticle the circle areas double progressively, hence the diameters alter by Root 2, so that the size classes can form a continuation of the standard series of sieves for particle sizing. Each particle is assigned to a size class defined by two adjacent circles which represent the size limits of that class. Thus the distribution of size is obtained in terms of the diameter of circles having the same projected area as the particles. This method will cover particles in the range 150 micron to 0.38 micron. The size distributions with respect to their number and weight are determined separately. Final results are calculated as cumulative percents. Actual size of circles and globes are nominally 560 $\mu$ , 400 $\mu$ , 280 $\mu$ , 200 $\mu$ , 149 $\mu$ , 100 $\mu$  and 70 $\mu$ .

Circle 1 is defined as 1 unit.

Originally designed by the National Coal Board for use in coal mining.

References: BS3625/BS3260

Pattern	Description	Diameter	Order Code
NG10	British standard (BS3625/BS3260) globes & circles.	16mm	01B16252
		19mm	01B19252
		21mm	01B21252
		23mm	01B23252
		24mm	01B24252
		26mm	01B26252
		27mm	01B27252
		Special	01BSP252

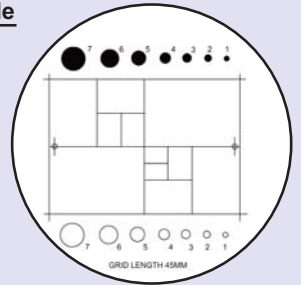

## Fairs

### NG5

Designed to extend the sizing range of globe and circle reticles. Example: Used in conjunction with NG2 the overall size range = 128:1. The circles increase by root 2. Note that both reticles would have to be used with the same microscope, eyepiece and objective.

Reference: G.L Fairs Chem Ind. 1943 Vol. 62. Pp 374-378. "The Use Of The Microscope In Particle Size Analysis."

12 Drawings not to scale

Pattern	Description	Diameter	Order Code
NG5	Fairs.	16mm	01A16077
		19mm	01A19077
		21mm	01B21077
		23mm	01A23077
		24mm	01A24077
		26mm	01A26077
		27mm	01A27077
		Special	01BSP077

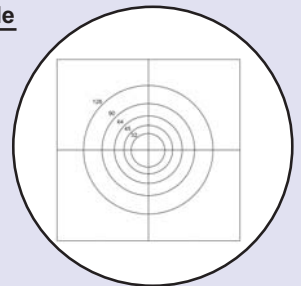



## Asbestos Fibre Analysis - Walton & Beckett Reticle

### G22,G24

Calibration factors are required for each of these reticles, see note below. The Walton and Beckett reticle is used for counting fibrous dust (e.g. asbestos or glass fibres) and is particularly useful where the majority of fibres to be counted are shorter than 5 micron. The circle is divided into four by two diametrical lines scaled in units of 5 and 3 microns respectively. 3 and 5 microns are the critical measurements of fibre lengths and diameter used in fibre counting. Unlike the usual globes of other particle reticles the Walton and Beckett has a series of shapes to compare objects with. These shapes have been designed for comparison with fibres, especially since they incorporate an aspect ratio of 3:1 or 5:1 essential for such analysis. Reference: W.H.Walton and S.T.Beckett, Occupational Hygiene. Vol. 20 pp 19-23. "A Microscope Eyepiece For The Evaluation of Fibrous Dusts."

Pattern	Description	Diameter	Order Code
G22	Walton & Beckett for asbestos. 3:1 ratio.	16mm	01A16062
		19mm	01A19062
		21mm	01B21062
		23mm	01A23062
		24mm	01A24062
		26mm	01A26062
		27mm	01A27062
	Special	01BSP062	

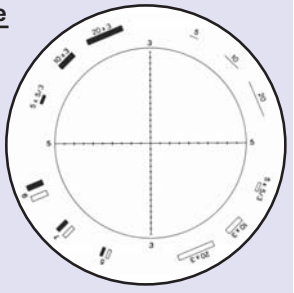

Pattern	Description	Diameter	Order Code
G24	Walton & Beckett for asbestos. 5:1 ratio.	16mm	01B16063
		19mm	01B19063
		21mm	01B21063
		23mm	01B23063
		24mm	01B24063
		26mm	01B26063
		27mm	01B27063
	Special	01BSP063	

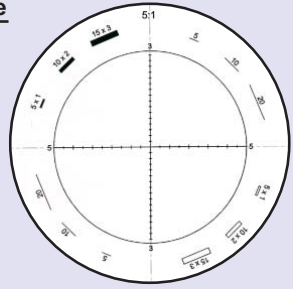

### G25

Based on the G22, the G25 is produced to a new design by the Institute of Occupational Health.

Pattern	Description	Diameter	Order Code
G25	Walton & Beckett for asbestos (1996).	16mm	01A16085
		19mm	01A19085
		21mm	01B21085
		23mm	01A23085
		24mm	01A24085
		26mm	01A26085
		27mm	01A27085
	Special	01BSP085	

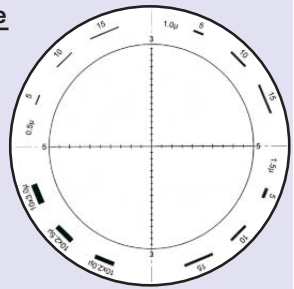

**IMPORTANT NOTE.** The circle on these Walton & Beckett reticles must represent 100 microns at the stage and each one must be manufactured to suit the individual instrument. Therefore, details should be provided with your order of :- Calibration factor, if known or Objective magnification, eyepiece magnification, diameter of reticle disc required, microscope make and model.

All Walton & Beckett reticles are normally used with 40x objectives giving a calibration factor of 4. In some microscopes there is also an additional 1.25x magnification to give a total objective magnification of 50x - these will have a calibration factor of 5. All standard Walton & Beckett reticles are supplied with a calibration factor of 4. Other calibration factors are made to special order. These reticles will require a calibrated stage micrometer to verify the sizes - See S12 or PS12 in Calibration Standards Brochure. For phase contrast verification see also S84.

# SPECIALIST DESIGNS

## Spray Droplet Sizing Reticle (Matthews)

### NG30

For size and distribution assessments of aerosol droplets. Used in conjunction with the Pyser 40x microscope for direct measurements of droplets from 50 to 400 microns diameter. Actual pattern sizes are 50, 100, 200 and 400 microns. W.H.O. (Details on request) and G.A. Matthews. Imperial College.

Pattern	Description	Diameter	Order Code
NG30	Matthews spray droplet.	16mm	01B16261
		19mm	01B19261
		21mm	01B21261
		23mm	01B23261
		24mm	01B24261
		26mm	01B26261
		27mm	01B27261
		Special	01BSP261

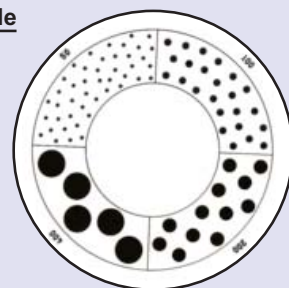

## Thompson

### G23

For counting particles in any of three areas of known size. The graticle is calibrated in the same manner as a normal eyepiece scale. The result is then used to calculate the area of any square.

Pattern	Description	Diameter	Order Code
G23	Thompson for dust analysis. 10mm, 7mm and 4mm squares with 10mm scale in 0.1mm divisions and cross lines	16mm	01A16056
		19mm	01A19056
		21mm	01A21056
		23mm	01B23056
		24mm	01A24056
		26mm	01A26056
		27mm	01A27056
		Special	01BSP056

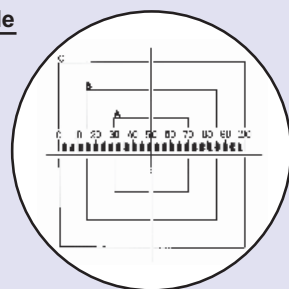

## Chalkley Point Array

### NG52

This is used to quickly determine the relationship of components to each other using random sampling. An example of its application is given by Curtis, where a researcher might want to see whether or not a certain drug affects the volume proportion of cell types in a given organ. With this reticle the proportion of points lying over the image of one type of component is statistically proportional to the area occupied by that component. The 25 points of the array are placed over the field of view at random, so that a comparison can be made between the number of points touching the one type of component, with the number touching the other type of component in each viewing. A series of observations will yield an increasingly accurate ratio of the comparative incidence of each type of particle. Ref. A.S.C.Curtis. Medical and Biological Illustration, Vol. 10. pp 261- 266. "Area and Volume Measurements by Random Sampling Methods"

Pattern	Description	Diameter	Order Code
NG52	Chalkley point array.	16mm	01B16257
		19mm	01B19257
		21mm	01B21257
		23mm	01B23257
		24mm	01B24257
		26mm	01B26257
		27mm	01B27257
		Special	01BSP257

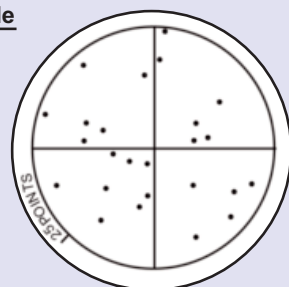

## Pharmaceutical PSA Pattern

### G57

This reticle was designed for the pharmaceutical industry. However, it is also useful where particle size considerations are restricted to  $10\mu$  and  $25\mu$ . Dots and circles give quick references for these two sizes. In addition a scale is incorporated.

The microscope must be calibrated when ordering this reticle, such that the circle must equate to 1mm on the microscope stage.

Reference: The United States Pharmaceutical Conventions Inc. Pharmaceutical Forum Vol.19 No.6.

This reticle is normally used with a 10x objective: calibration factor of 1. If a different objective magnification is used then a calibration factor will be needed to allow us to make it to the correct size. S8 and PS8 are recommended stage micrometers for use with this reticle.

Pattern	Description	Diameter	Order Code
G57	Pharmaceutical PSA Pattern.	19mm	01A19076
		21mm	01A21076
		23mm	01A23076
		24mm	01A24076
		26mm	01A26076
		27mm	01A27076
		Special	01ASP076

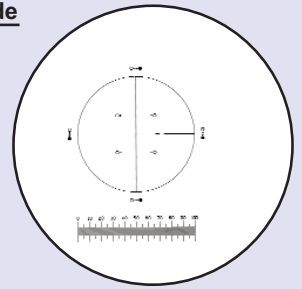

## Counting Pattern

### NG14

Simple counting for geological and soil analysis.

Reference: L.G.Briarty. "Stereology : Methods for Quantitative Light and Electron Microscopy." Sci. Prog. Oxf. 1975 62; 1-32

Pattern	Description	Diameter	Order Code
NG14	Counting pattern for soil analysis. 10mm square.	16mm	01B16254
		19mm	01B19254
		21mm	01B21254
		23mm	01B23254
		24mm	01B24254
		26mm	01B26254
		27mm	01B27254
		Special	01BSP254

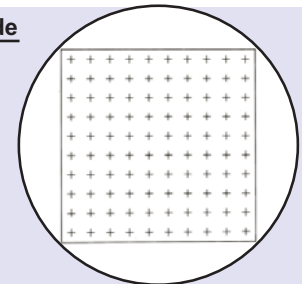

## Lennox Grain Analysis

### NG21

Pattern	Description	Diameter	Order Code
NG21	Lennox for grain analysis.	16mm	01B16255
		19mm	01B19255
		21mm	01B21255
		23mm	01B23255
		24mm	01B24255
		26mm	01B26255
		27mm	01B27255
Special	01BSP255		

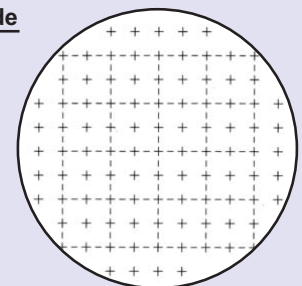

## Kotter

### G48

Reference: I.S.O. 7404-4: 1988 (E). Methods for Analysis of Bituminous Coal and Anthracite. Part 4 and Methods of Determining Microlithotype Composition.

Normally used with 20x objective = calibration factor of 1. For use with 40x objective specify calibration factor of 2, for 50x specify 2.5. For other objective magnifications the reticle will need to be custom made.

Pattern	Description	Diameter	Order Code
G48	Kotter pattern. Note: This pattern requires a calibration factor.	16mm	01A16072
		19mm	01A19072
		21mm	01A21072
		23mm	01B23072
		24mm	01A24072
		26mm	01A26072
		27mm	01A27072
Special	01BSP072		

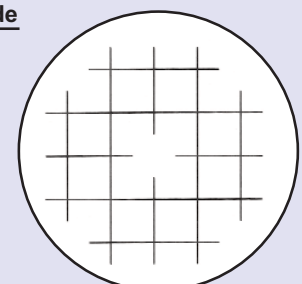

## Zeiss Integrating Eyepiece Disc 1 or Henning Reseau Pattern 25 points

### G49

Reference: Zeiss Werkzeitschrift.

Pattern	Description	Diameter	Order Code
G49	Henning Reseau pattern. (Zeiss integrating disc 1)	16mm	01A16073
		19mm	01A19073
		21mm	01B21073
		23mm	01A23073
		24mm	01A24073
		26mm	01A26073
		27mm	01A27073
		Special	01BSP073

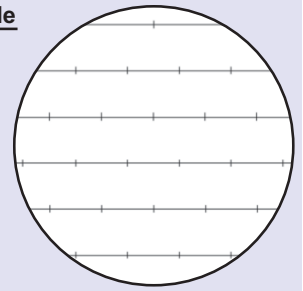

## Zeiss Integrating Eyepiece Disc 100

### G47

Similar to G49 but extended to 100 points, which are indexed.

Pattern	Description	Diameter	Order Code
G47	Zeiss Integrating eyepiece disc.	16mm	01A16090
		19mm	01A19090
		21mm	01B21090
		23mm	01A23090
		24mm	01A24090
		26mm	01A26090
		27mm	01A27090
		Special	01BSP090

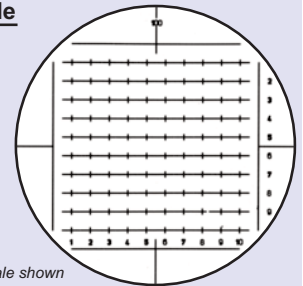

## Integrating Eyepiece

### G50

Pattern	Description	Diameter	Order Code
G50	Integrating eyepiece (simplified).	19mm	01B19075
		21mm	01B21075
		23mm	01B19075
		24mm	01B19075
		27mm	01B19075
		26mm	01B19075
		Special	01BSP075

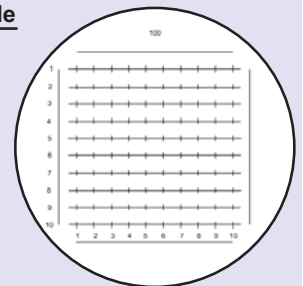

## STEREOLOGY

In its simplest form, stereology is the science where information about a three dimensional object is obtained from only a two-dimensional section of that structure.

Measurements are usually made with these reticles in the following manner:-

1. An adequate representation of sections of a specimen is obtained.
2. The reticle is superimposed upon the specimen (or micrograph/projected image of the section).
3. Finally, the interaction between the superimposed reticle and the test sections are recorded.

An overall introduction is given by: L.G.Briarty. "Stereology : Methods for Quantitative Light and Electron Microscopy." Sci. Prog. Oxf. 1975 62; 1-32

## The Mertz Reticle (36 point)

### NGM1

Used to estimate the three dimensional surface areas or the surface density of a component in a given volume, when the component does not have a random orientation. It comprises a test system with parallel curved lines used for measuring the intersection of points. Reference: W.A.Mertz . " Mikroskopie" Vol. 22 1967 pp 132-142.

Pattern	Description	Diameter	Order Code
NGM1	Mertz for stereology.	16mm	01B16258
		19mm	01B19258
		21mm	01B21258
		23mm	01B23258
		24mm	01B24258
		26mm	01B26258
		27mm	01B27258
Special	01BSP258		

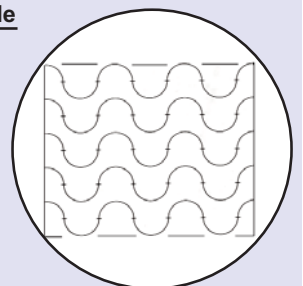

## Weibel 1

### NGW1

15 lines of equal length connecting the verticals of a regular hexagonal point network.  
Reference: E.R.Weibel Lab. Invest. Vol. 22 pp131-152. Principles and Methods for the Morphometric Study of the Lung and Other Organs.

Pattern	Description	Diameter	Order Code
NGW1	Weibel Type 1 for stereology.	16mm	<b>01B16259</b>
		19mm	<b>01B19259</b>
		21mm	<b>01B21259</b>
		23mm	<b>01B23259</b>
		24mm	<b>01B24259</b>
		26mm	<b>01B26259</b>
		27mm	<b>01B27259</b>
		Special	<b>01BSP259</b>

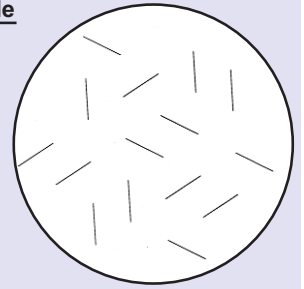

## Weibel 2

### NGW2

Used when making a surface to volume ratio of a structure per mass unit. This reticle consists of a number of short lines with interruptions as long as the lines. Basically, the number of intersections falling over the short lines are counted and the number of endpoints falling on the end of the structure are determined.

Pattern	Description	Diameter	Order Code
NGW2	Weibel Type 2 for stereology.	16mm	<b>01B16260</b>
		19mm	<b>01B19260</b>
		21mm	<b>01B21260</b>
		23mm	<b>01B19260</b>
		24mm	<b>01B19260</b>
		26mm	<b>01B19260</b>
		27mm	<b>01B19260</b>
		Special	<b>01BSP260</b>

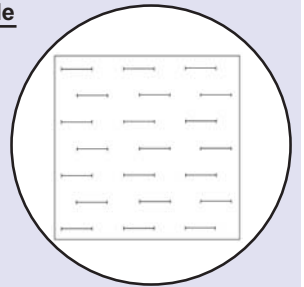

Reference: E.R.Weibel, Journal of Microscopy Vol. 95. Pp 373-378. Current Capabilities and Limitations of Available Stereological Techniques, point counting method.

## Weibel 3

### GW3

Reference: E.R.Weibel, G.S.Kistler & W.F.Scherle. 1966. J.Cell Biology. 30,23.

Pattern	Description	Diameter	Order Code
GW3	Weibel Type 3 for stereology.	16mm	<b>01A16074</b>
		19mm	<b>01A19074</b>
		21mm	<b>01B21074</b>
		23mm	<b>01A23074</b>
		24mm	<b>01A24074</b>
		26mm	<b>01A26074</b>
		27mm	<b>01A27074</b>
		Special	<b>01BSP074</b>

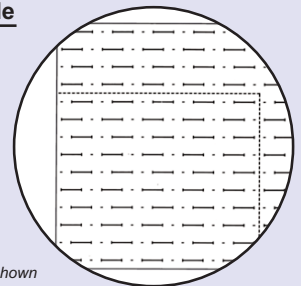

*Part image shown*

# METALLURGY

Standard pattern discs for metallurgical stereometric analysis of grain size in polished metal sections.

## Grain Sizing Patterns EN10247/ISO4976

For the determination of non-metallic inclusion content of steel.

NG60 meets EN10247 & NG61 meets ISO 4967. Both are scaled for use with 10x objective magnification.

Pattern	Description	Diameter	Order Code
NG60 NEW	Grain Sizing reticle to EN10247.	21mm	01B21265
		23mm	01B23265
		24mm	01B24265
		26mm	01B26265
		27mm	01B27265
		Others	

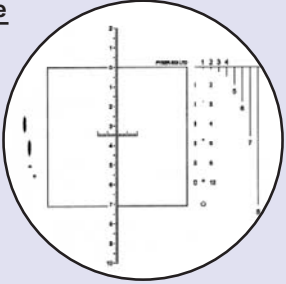

Pattern	Description	Diameter	Order Code
NG61 NEW	Grain Sizing reticle to ISO4967.	21mm	01B21266
		23mm	01B23266
		24mm	01B24266
		26mm	01B26266
		27mm	01B27266
		Others	

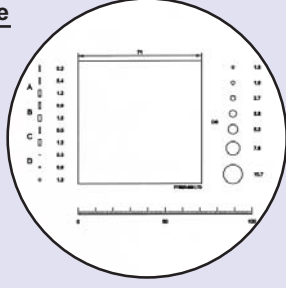

## ASTM Austenite 1:1 Grain Sizing Disc

G41  
Reference: VDEH 1510-61

Pattern	Description	Diameter	Order Code
G41	ASTM Grain sizing austenite.	19mm	01A19064
		21mm	01B21064
		23mm	01A23064
		24mm	01A24064
		26mm	01A26064
		27mm	01A27064
		Special	01BSP064

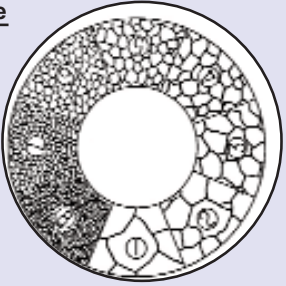

## ASTM E112 Plate 1 Grain Sizing Disc

G42

Pattern	Description	Diameter	Order Code
G42	Grain sizing E112.	19mm	01A19065
		21mm	01B21065
		23mm	01A23065
		24mm	01A24065
		26mm	01A26065
		27mm	01A27065
		Special	01BSP065



## ASTM Carbide grain sizing chart

G43

Pattern	Description	Diameter	Order Code
G43	ASTM Grain sizing carbide.	19mm	01A19066
		21mm	01B21066
		23mm	01A23066
		24mm	01A24066
		26mm	01A26066
		27mm	01A27066
		Special	01BSP066





## ASTM E45

### G44

For some applications customers require the square to be 10mm x 10mm.  
Please state special on order for this version

Pattern	Description	Diameter	Order Code
G44	ASTM Grain sizing Root 2 sides. 7.1mm square, 10mm scale.	19mm 21mm 23mm 24mm 26mm 27mm Special	01A19086 01A21086 01A23086 01A24086 01A26086 01A27086 01ASP086

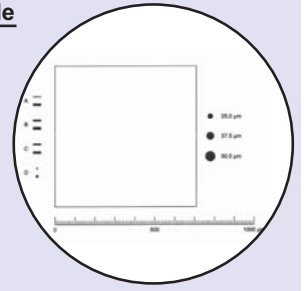

## ASTM E19-46 Grain sizing disc

### G45

Pattern	Description	Diameter	Order Code
G45	ASTM Grain sizing E19-46.	19mm 21mm 23mm 24mm 26mm 27mm Special	01A19067 01B21067 01A23067 01A24067 01A26067 01A27067 01BSP067

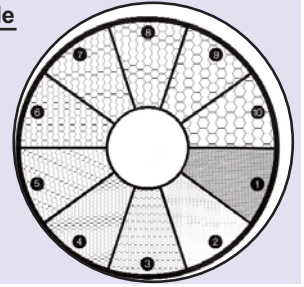

## ASTM E19-46 Grain sizing disc root 2

### G46

Pattern	Description	Diameter	Order Code
G46	ASTM Grain sizing E19-46. Root 2	19mm 21mm 23mm 24mm 26mm 27mm Special	01A19068 01B21068 01A23068 01A24068 01A26068 01A27068 01BSP068

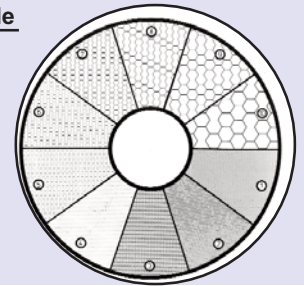

## Circular grid ASTM 24 points

### G54

Reference: ASTM E562

Pattern	Description	Diameter	Order Code
G54	ASTM 24 point circular grid.	19mm 21mm 23mm 24mm 26mm 27mm Special	01A19078 01B21078 01A23078 01A24078 01A26078 01A27078 01BSP078

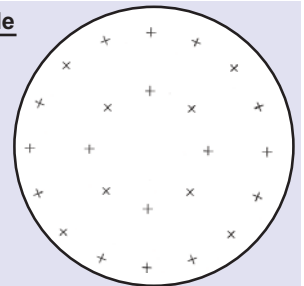

## Square grid ASTM 25 points

### G55

Reference: ASTM E562

Pattern	Description	Diameter	Order Code
G55	ASTM 25 point Square grid.	19mm 21mm 23mm 24mm 26mm 27mm Special	01A19079 01B21079 01A23079 01A24079 01A26079 01A27079 01BSP079

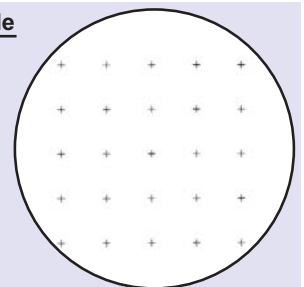

# Index by Type

	<i>Page</i>		<i>Page</i>
<b>LINES AND CROSSES</b>	<b>2-3</b>	<b>SPECIALIST DESIGNS</b>	<b>14</b>
Single Lines - NE50	2	Spray Droplet Sizing Reticle	14
Crosslines - NE8, NE81, NE82	2	Matthews - NG30	14
Broken Crosslines - NE56	2	Thompson - G23	14
Crossed Gauge Lines	3	Chalkley Point Array - NG52	14
		Pharmaceutical PSA Pattern - G57	15
<b>EYEPIECE SCALES</b>	<b>3-6</b>	Counting Pattern - NG14	15
Horizontal & Vertical Scales - NE120, NE1, NE2, NE5	3 3	Lennox Grain Analysis - NG21	15
NE28, NE41, NE20, NE31	4	Kotter - G48	15
Crossed Scales - NE17, NE18, NE72, NE70	5 5	Zeiss Integrating Eyepiece Disc 1 or Henning Reseau Pattern 25 points - G49	16 16
Scales with Crosslines - NE7, NE7N, NE77, NE777	5 6	Zeiss Integrating Eyepiece Disc 100 - G47	16
		Integrating Eyepiece - G50	16
<b>SQUARES &amp; GRIDS</b>	<b>6-9</b>	<b>STEREOLOGY</b>	<b>16</b>
Squared Grids - NE10, NE11, NE34	7	The Mertz Reticle (36 point) - NGM1	16
Indexed Grids - NE10A, NE11A, NE34A, NE71, NE35	7 8	Weibel 1 - NGW1	17
Chessboard Squares - NE15	8	Weibel 2 - NGW2	17
Squares & Grids - NE38	8	Weibel 3 - GW3	17
Miller Squares - NE57	8		
Whipple Grid - NE29	9	<b>METALLURGY</b>	<b>18-19</b>
		New Grain Sizing Patterns EN10247/ISO4976 NG60, NG61	18 18
<b>CIRCLE GAUGES &amp; PROTRACTORS</b>	<b>9-10</b>	ASTM Austenite 1:1 Grain Sizing Disc - G41	18
Concentric Circles - NE42, NE43, NE44, NE47	9 9	ASTM E112 Plate 1 Grain Sizing Disc - G42	18
NE48, NE22	10	ASTM Carbide Grain Sizing Chart - G43	18
Gauge Pairs - NE19	10	ASTM E45 - G44	19
Protractors	10	ASTM E19-46 Grain Sizing Disc - G45	19
Half Protractors - NE25	10	ASTM E19-46 Grain Sizing Disc Root 2 - G46	19
Full Protractor - NE45	10	Circular Grid ASTM 24 Points - G54	19
		Square Grid ASTM 25 points - G55	19
<b>PARTICLE SIZING &amp; DISTRIBUTION</b>	<b>11</b>		
Patterson Globes & Circles - NG1	11		
Porton - NG2	11		
New Porton - NG12	12		
British Standard Reticle - NG10	12		
Fairs - NG5	12		
Particle Analysis Test Slide - SG7	13		
Asbestos Fibre Analysis Walton & Beckett Reticle for Asbestos - G22, G24	13 13		
Walton & Beckett Reticle for Asbestos - G25	13		

# Index by Pattern

<b>NE1</b> Page 3	<b>NE120</b> Page 3	<b>NE2</b> Page 3	<b>NE5</b> Page 3	<b>NE7</b> Page 5	<b>NE7N</b> Page 5	<b>NE8</b> Page 2	<b>NE10</b> Page 7
<b>NE10A</b> Page 7	<b>NE11</b> Page 7	<b>NE11A</b> Page 7	<b>NE15</b> Page 8	<b>NE17</b> Page 5	<b>NE18</b> Page 5	<b>NE19</b> Page 10	<b>NE20</b> Page 4
<b>NE22</b> Page 10	<b>NE25</b> Page 10	<b>NE28</b> Page 4	<b>NE29</b> Page 9	<b>NE31</b> Page 4	<b>NE34</b> Page 7	<b>NE34A</b> Page 7	<b>NE35</b> Page 8
<b>NE38</b> Page 8	<b>NE41</b> Page 4	<b>NE42</b> Page 9	<b>NE43</b> Page 9	<b>NE44</b> Page 9	<b>NE45</b> Page 10	<b>NE47</b> Page 9	<b>NE48</b> Page 10
<b>NE50</b> Page 2	<b>NE53</b> Page 3	<b>NE54</b> Page 3	<b>NE56</b> Page 2	<b>NE57</b> Page 8	<b>NE70</b> Page 5	<b>NE71 NEW</b> Page 8	<b>NE72 NEW</b> Page 5
<b>NE77</b> Page 6	<b>NE81</b> Page 2	<b>NE82</b> Page 2	<b>NE777</b> Page 6	<b>NG1</b> Page 11	<b>NG2</b> Page 11	<b>NG5</b> Page 12	<b>NG10</b> Page 12
<b>NG12</b> Page 12	<b>NG14</b> Page 15	<b>NG21</b> Page 15	<b>G22</b> Page 13	<b>G23</b> Page 14	<b>G24</b> Page 13	<b>G25</b> Page 13	<b>NG52</b> Page 14
<b>NGM1</b> Page 16	<b>NGW1</b> Page 17	<b>NGW2</b> Page 17	<b>GW3</b> Page 17	<b>NG30</b> Page 14	<b>G41</b> Page 18	<b>G42</b> Page 18	<b>G43</b> Page 18
<b>G44</b> Page 19	<b>G45</b> Page 19	<b>G46</b> Page 19	<b>G47</b> Page 16	<b>G48</b> Page 15	<b>G49</b> Page 16	<b>G50</b> Page 16	<b>G54</b> Page 19
<b>G55</b> Page 19	<b>G57</b> Page 15	<b>SG7</b> Page 13	<b>NG60 NEW</b> Page 18	<b>NG61 NEW</b> Page 18			

# Other products

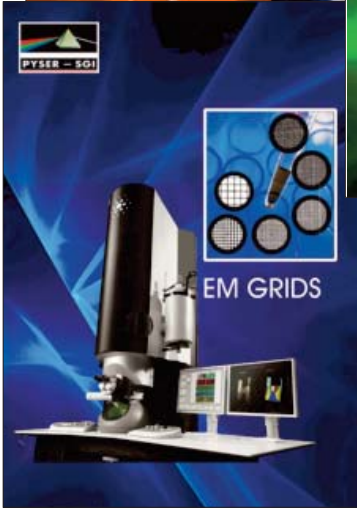
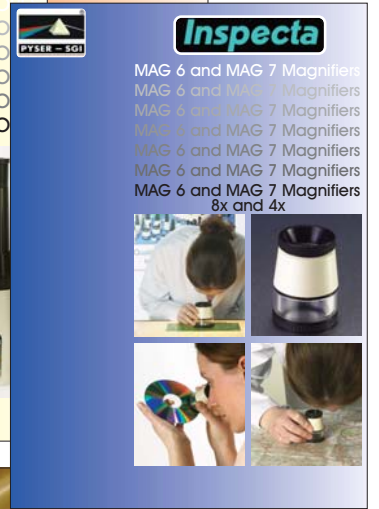
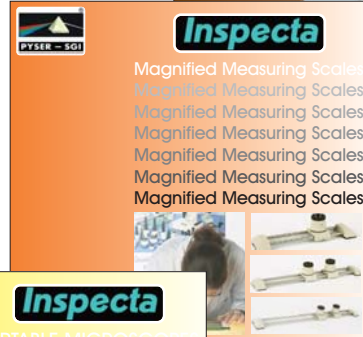
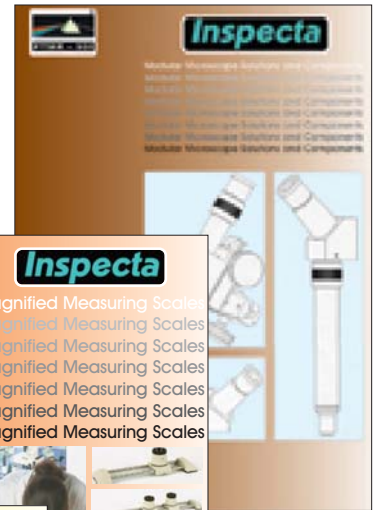
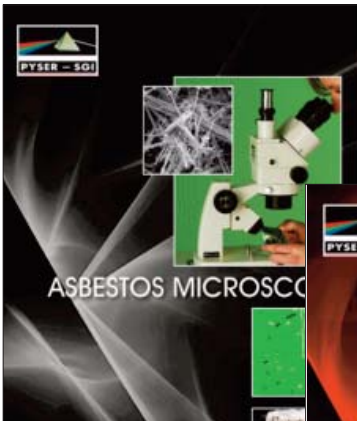

Please contact Pyser-SGI Limited



**PYSER - SGI LIMITED**  
 Fircroft Way, Edenbridge, Kent,  
 United Kingdom, TN8 6HA  
 Telephone: +44 (0)1732 864111  
 facsimile: +44 (0)1732 865544  
 Email: sales@pyser-sgi.com  
 www.pyser-sgi.com

July 2015 E & OE